

# BIONICLE®

VOROX



**WARNING: CHOKING HAZARD.**  
Toy contains small parts and a small ball.  
Not for children under 3 years.



8983

GLATORIAN



1

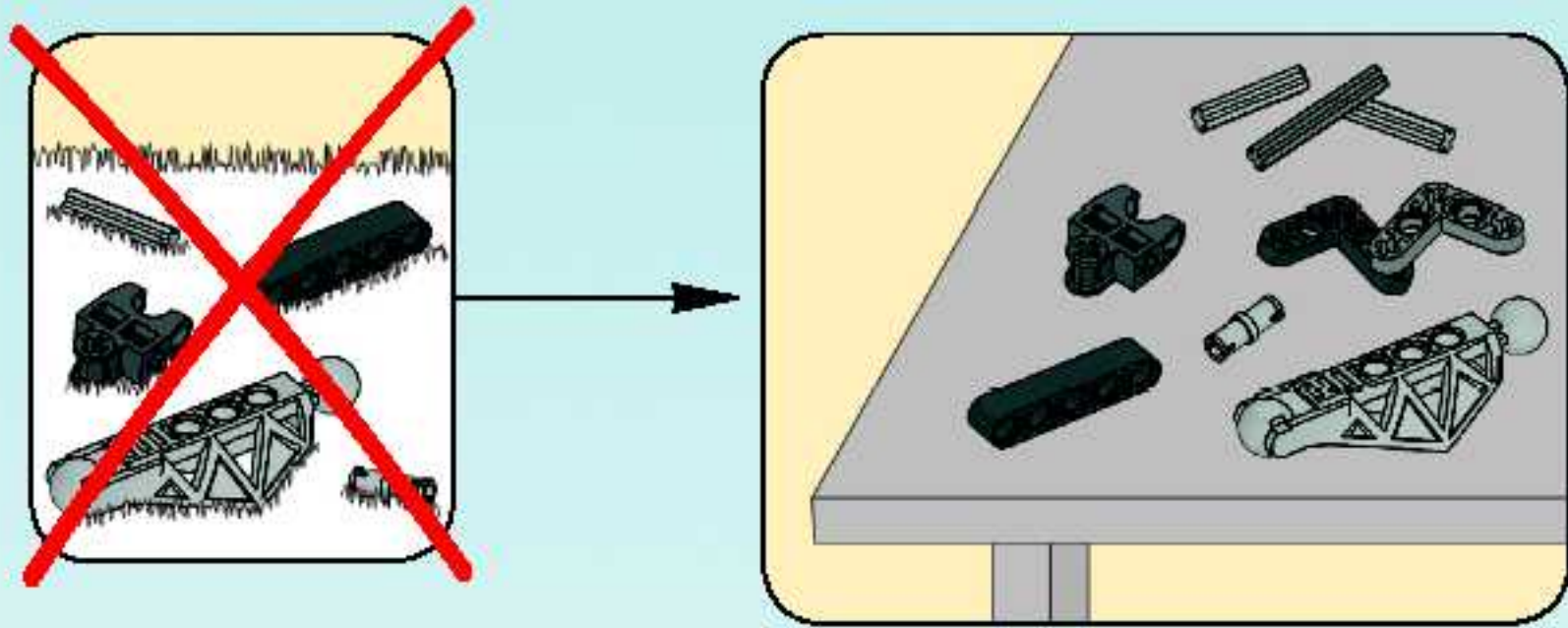

2

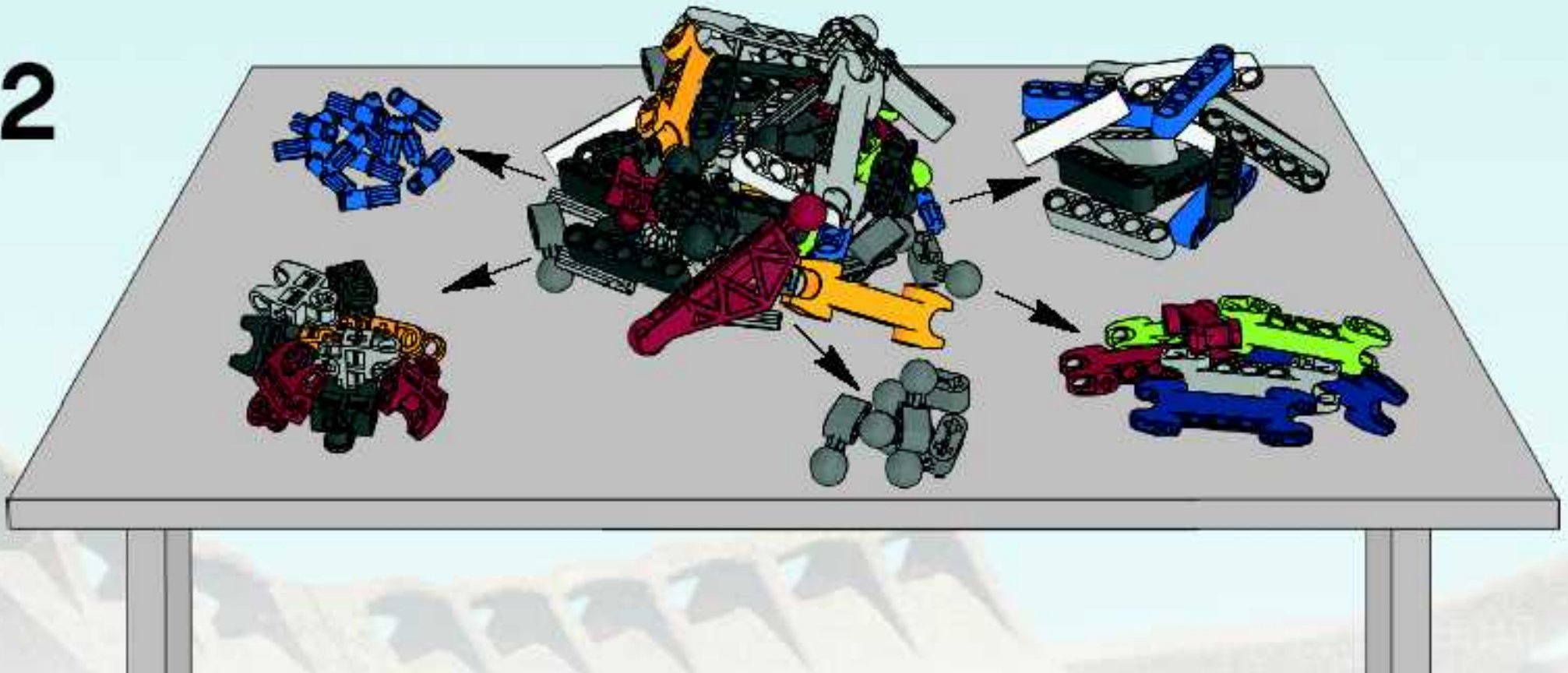

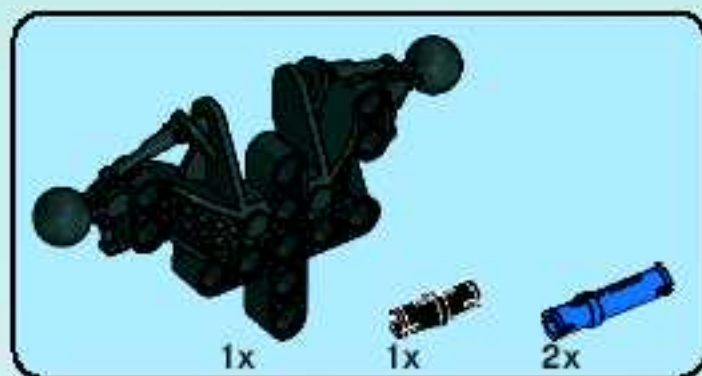

1

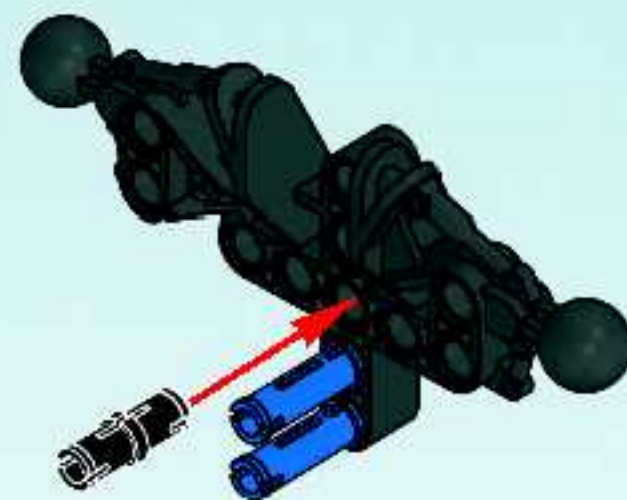

**AVERTISSEMENT : RISQUE D'ÉTOUFFEMENT.**  
Le jouet contient des petites pièces ainsi qu'une petite boule.  
Il ne convient pas aux enfants de moins de 3 ans.



**ADVERTENCIA: PELIGRO DE ASFIXIA.**  
Juguete que contiene partes pequeñas y una pelota pequeña.  
No recomendado para niños menores de 3 años.

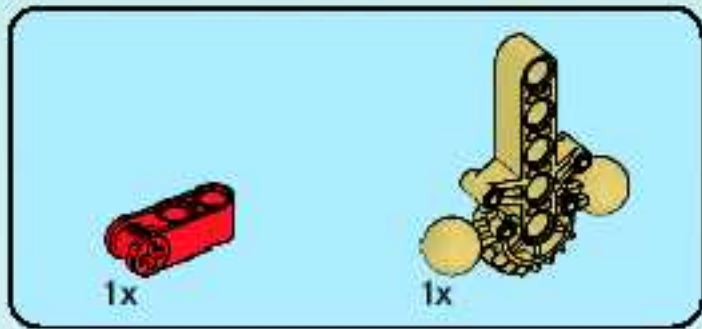

2

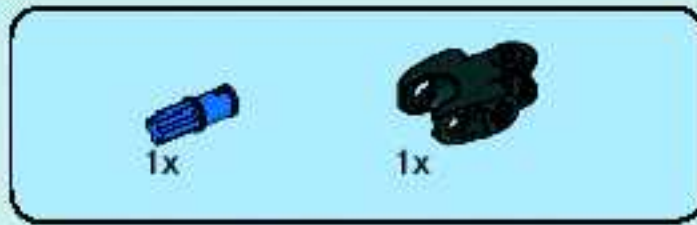
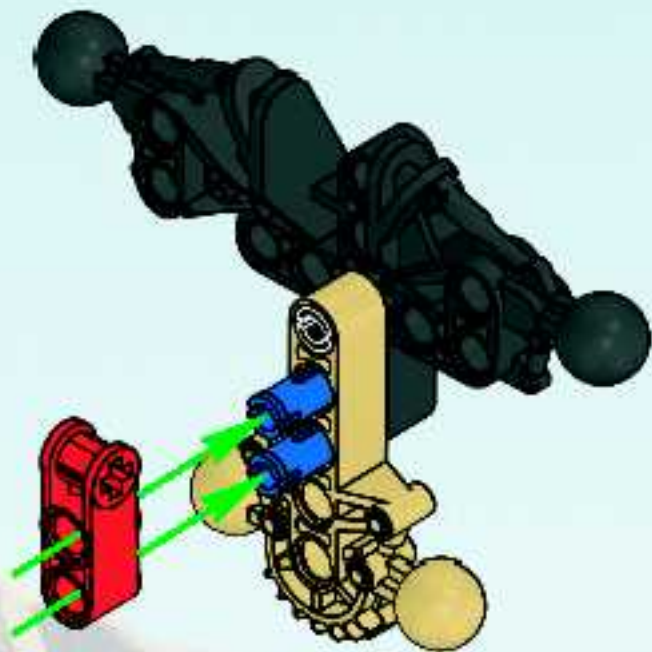

3

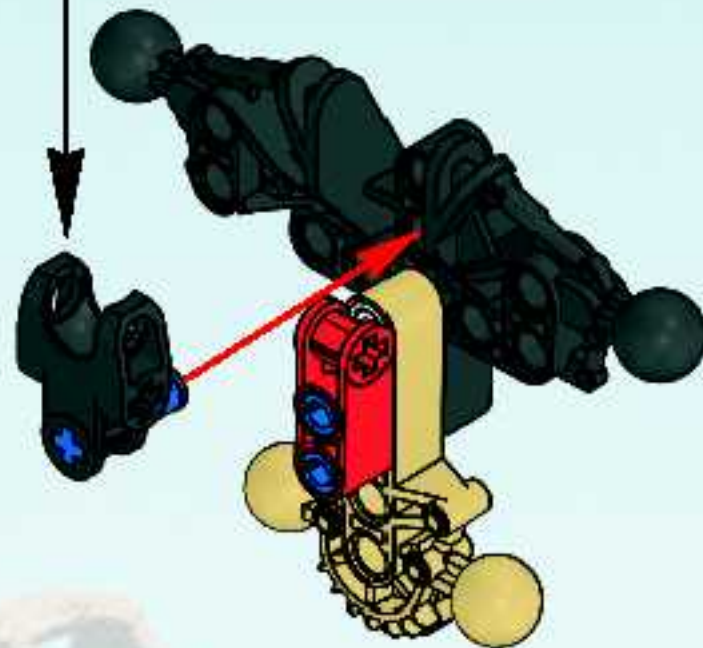
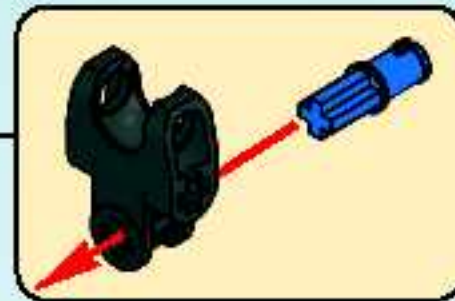

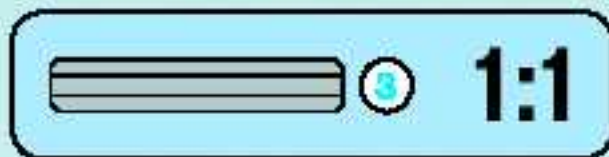
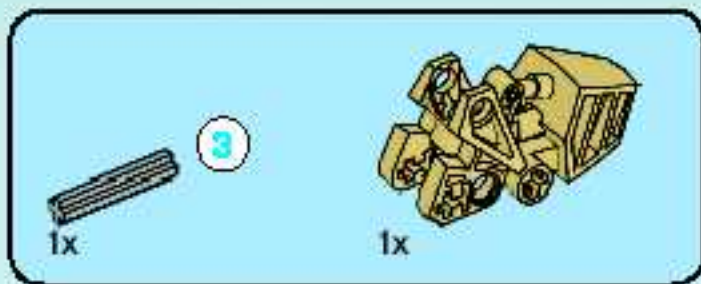

4

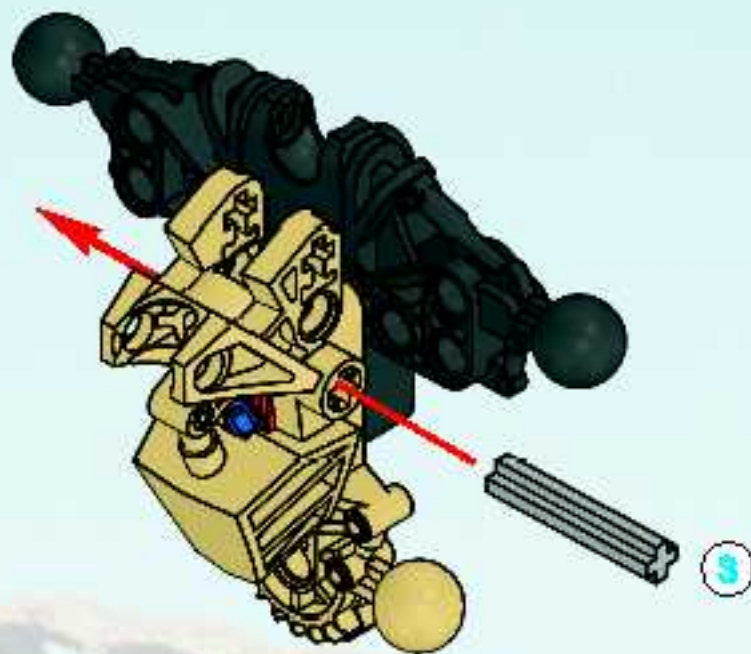

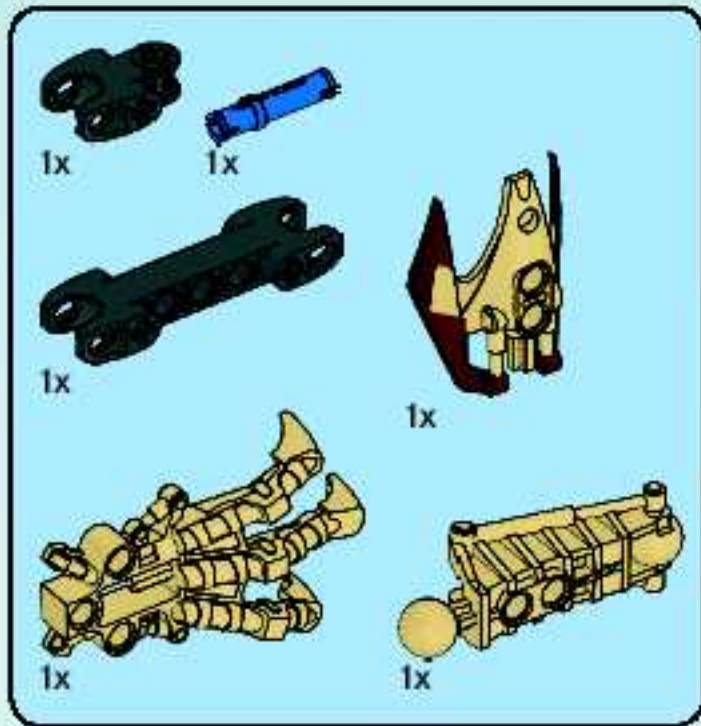

5

1

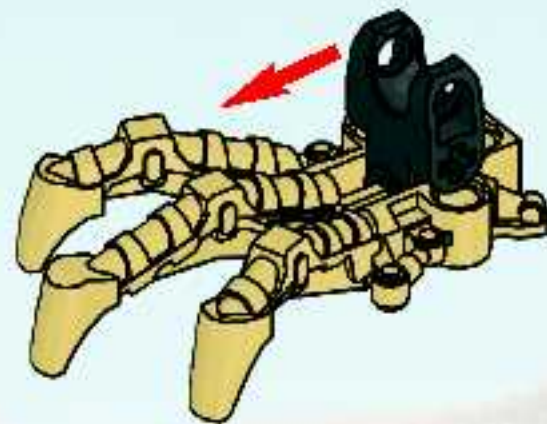

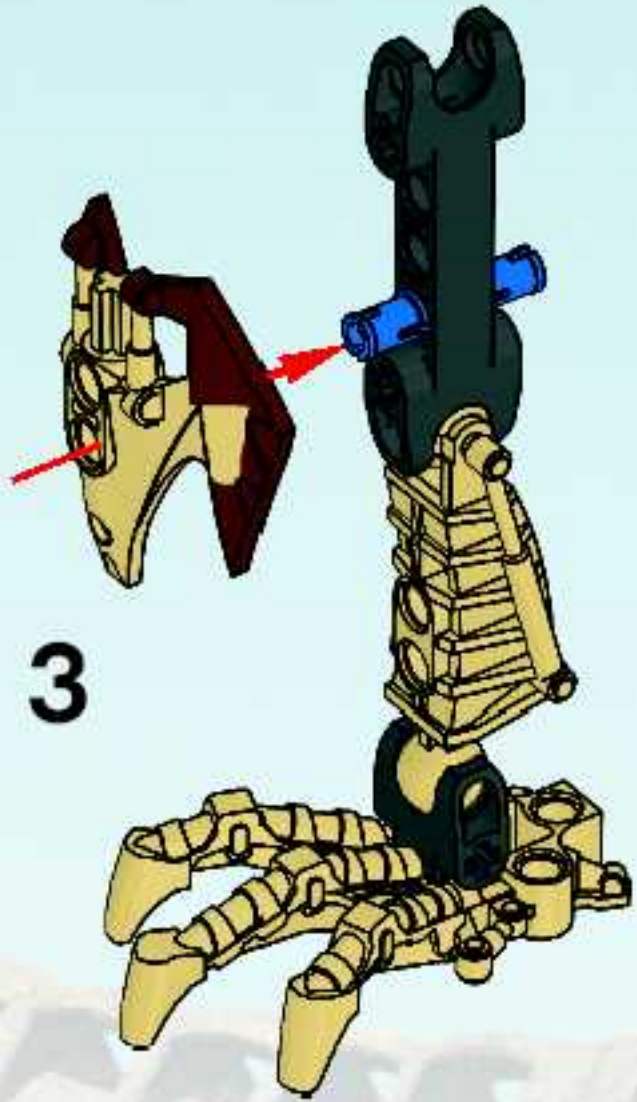
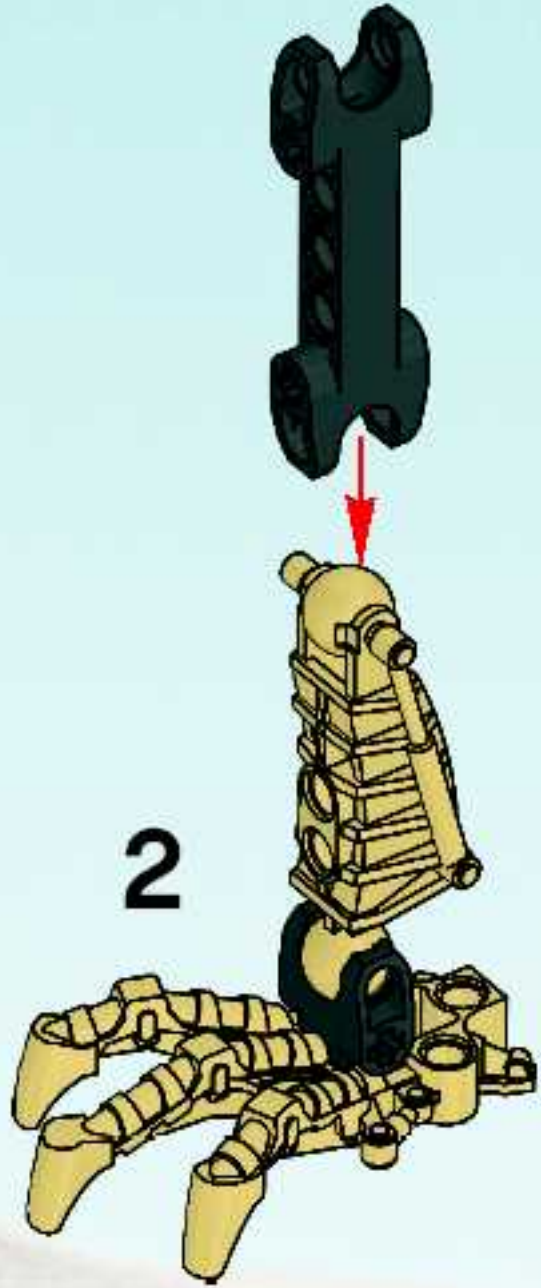

**2x**

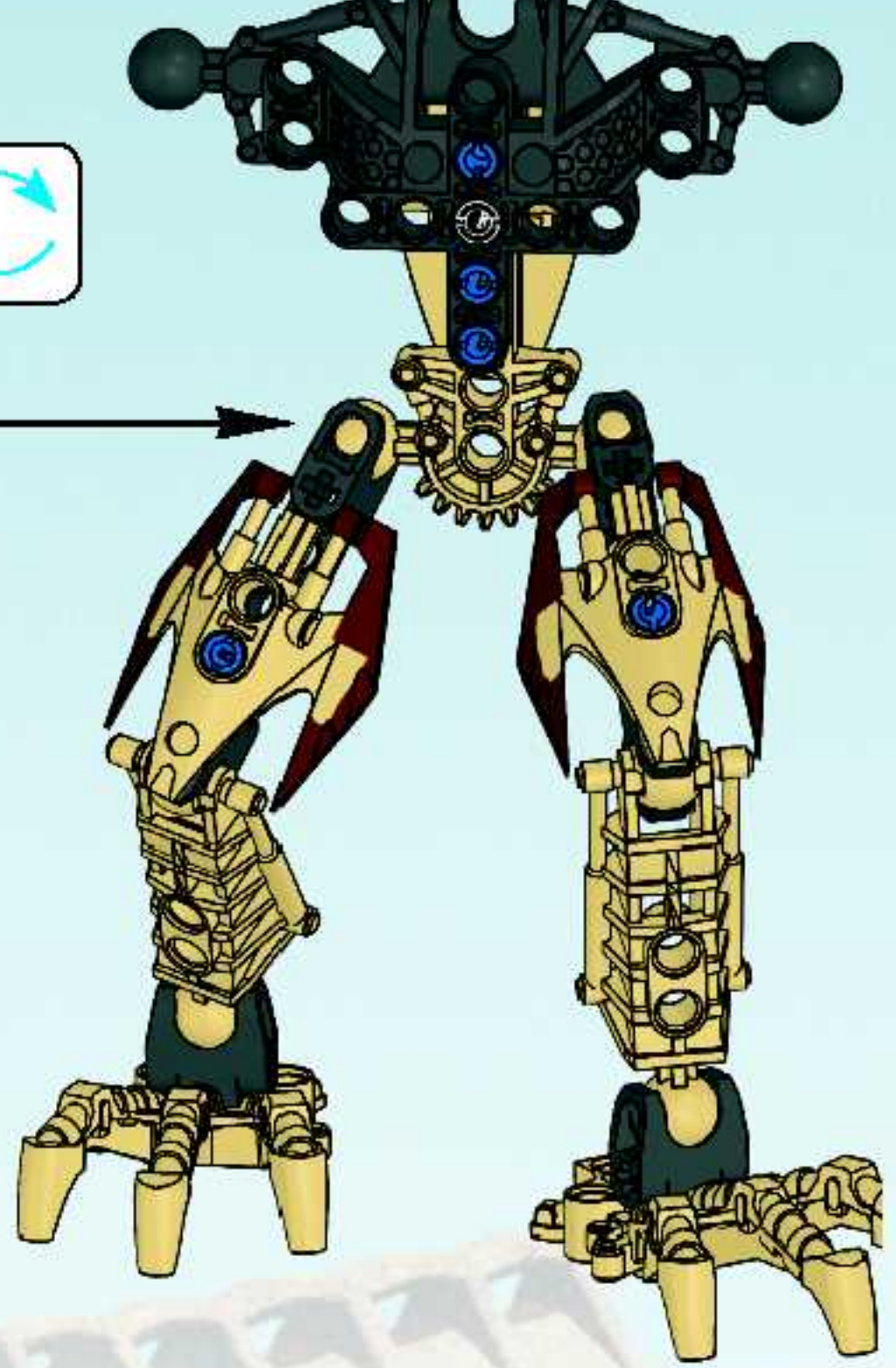



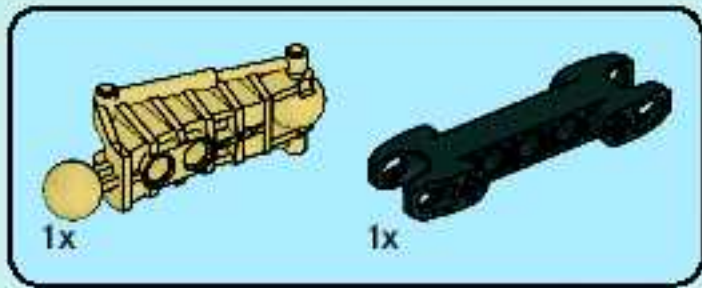

1

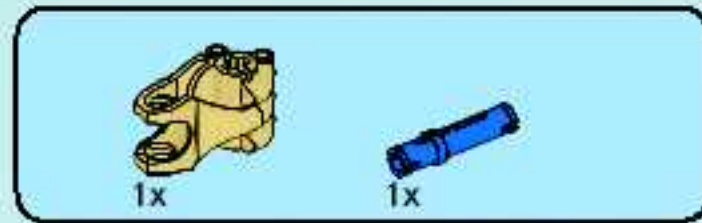

2

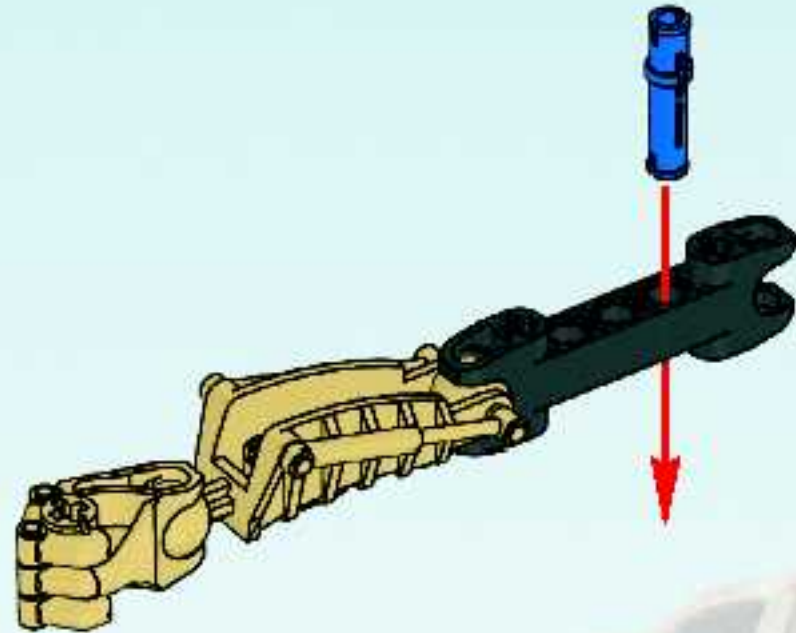
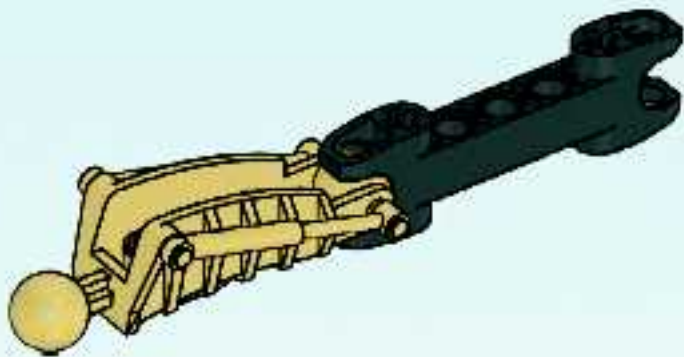

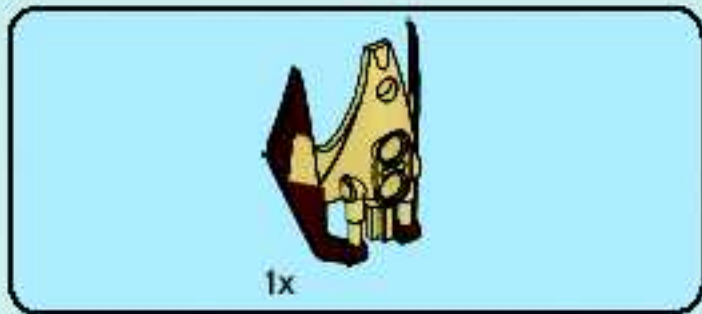

3

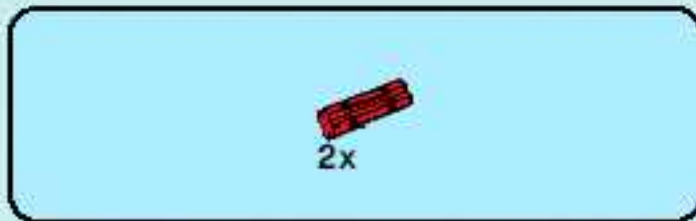
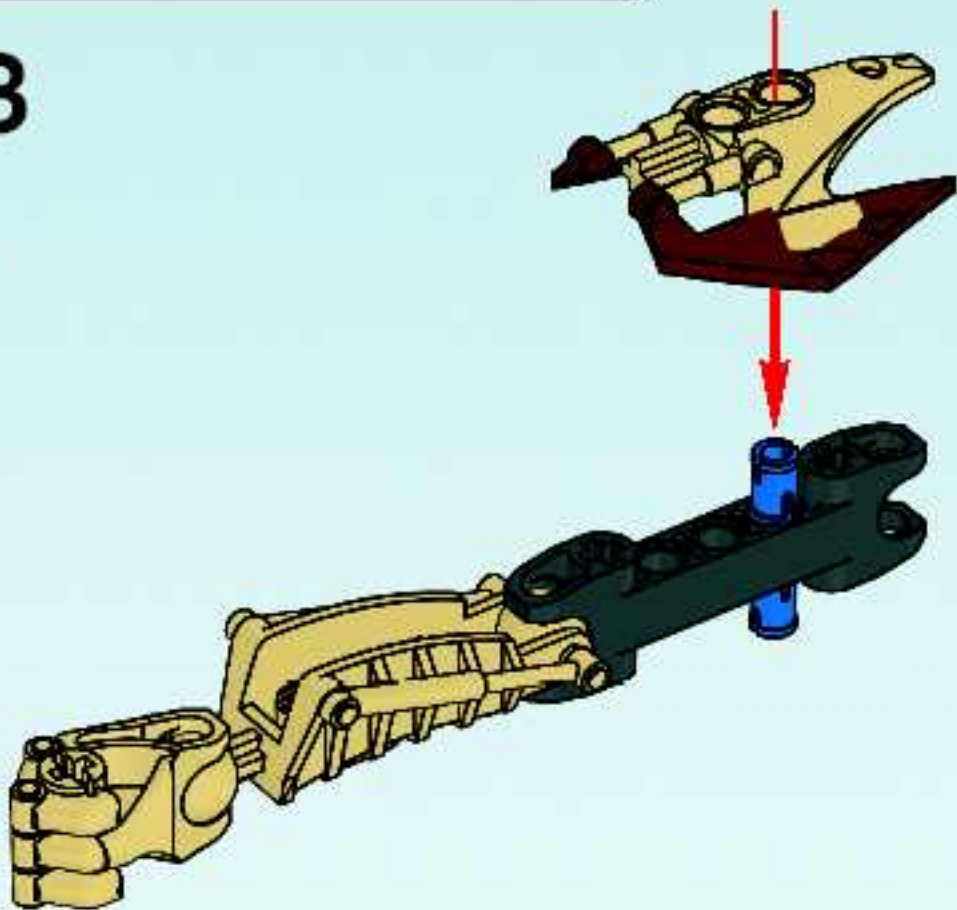

4

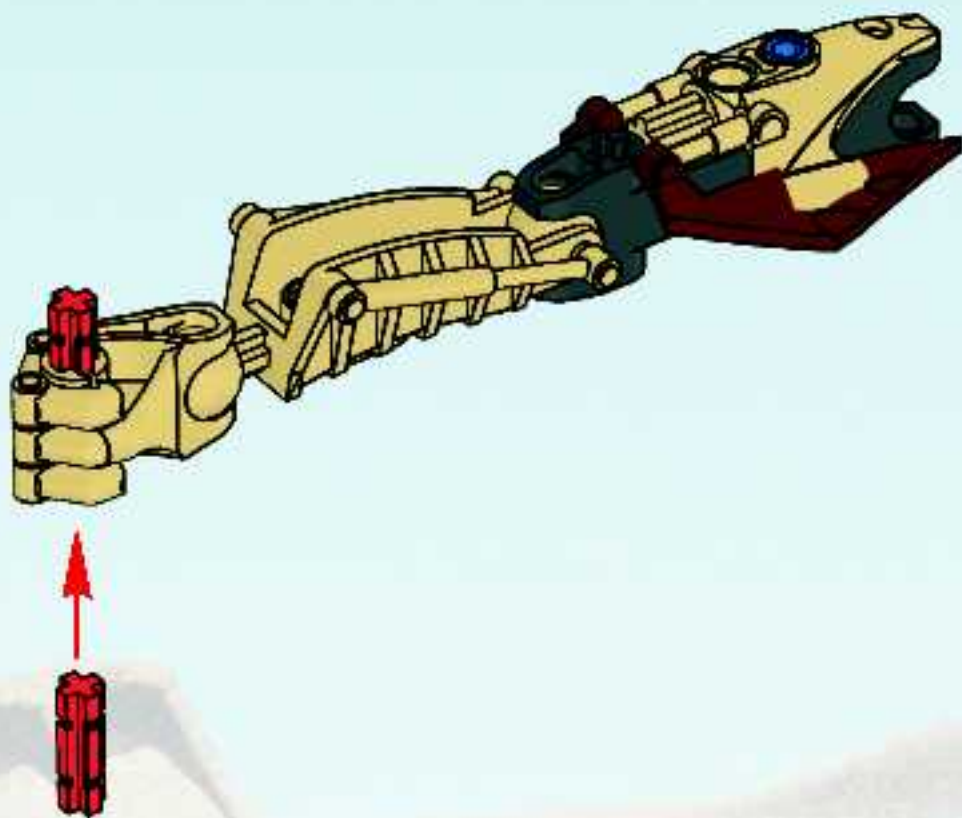

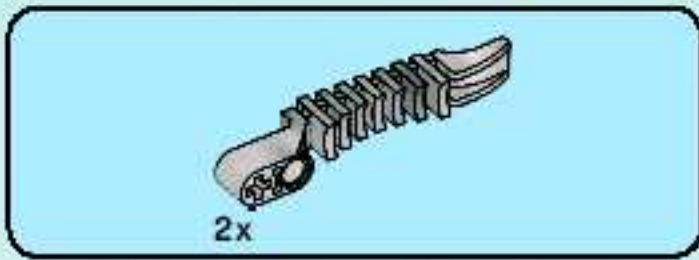

5

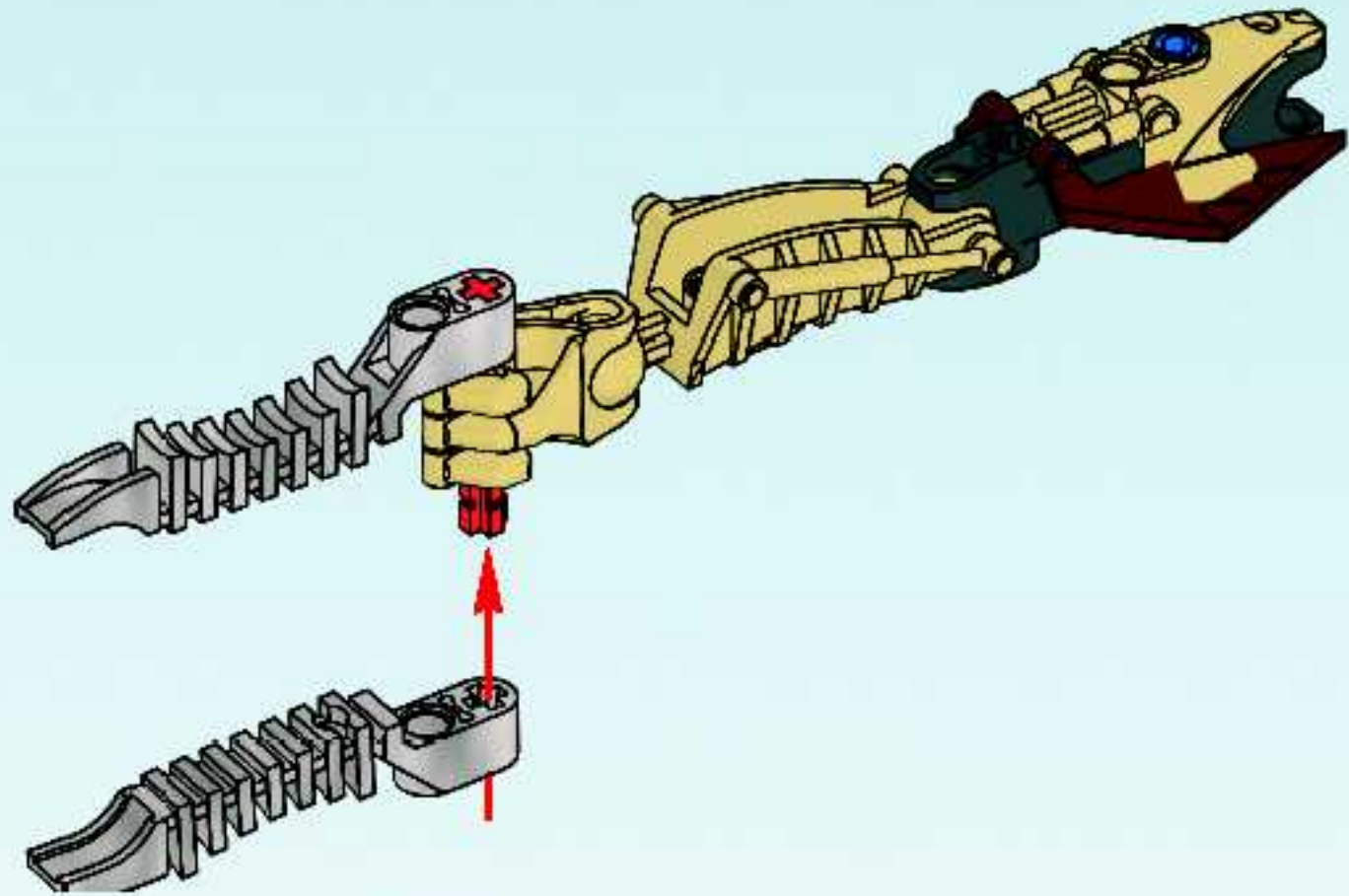



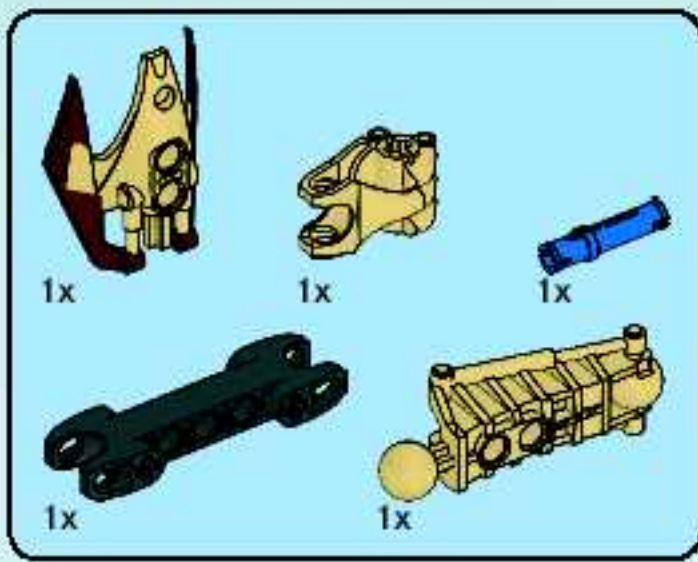

6

1

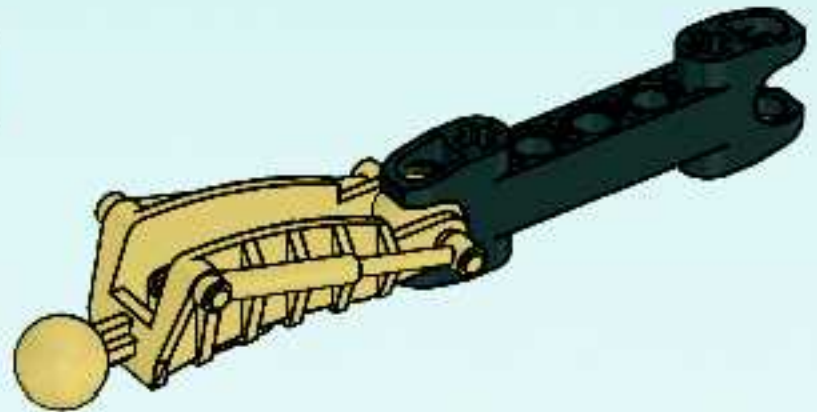

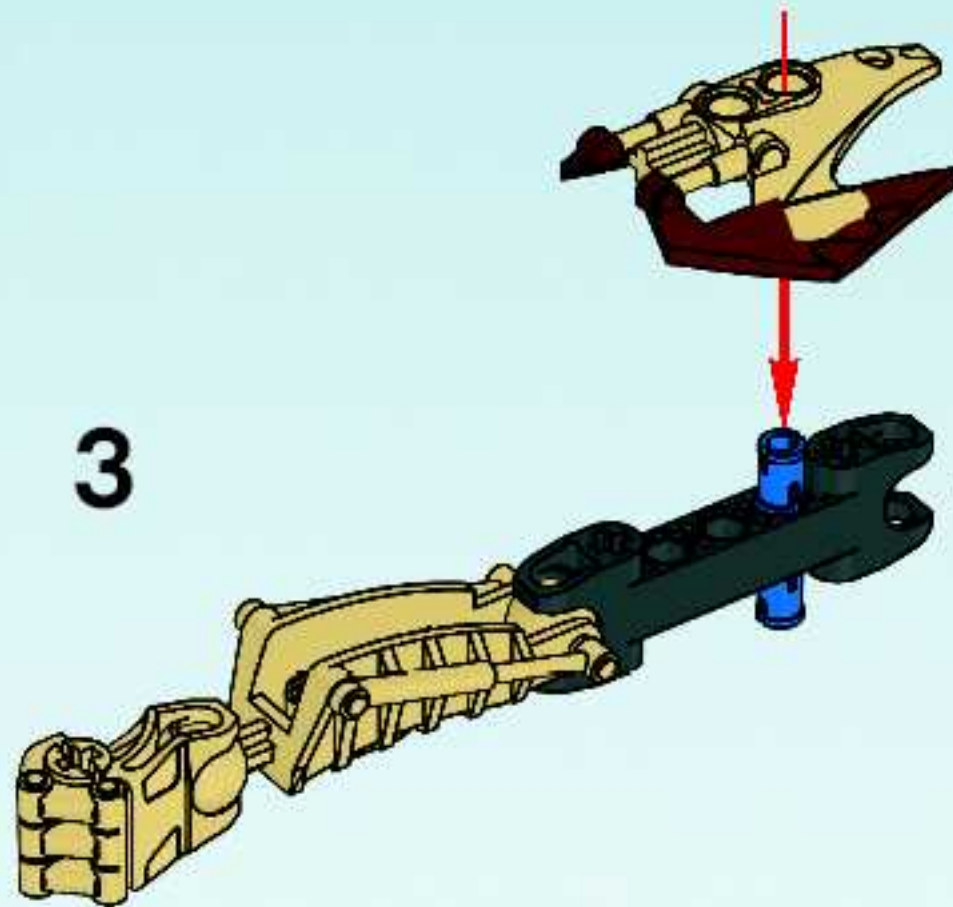
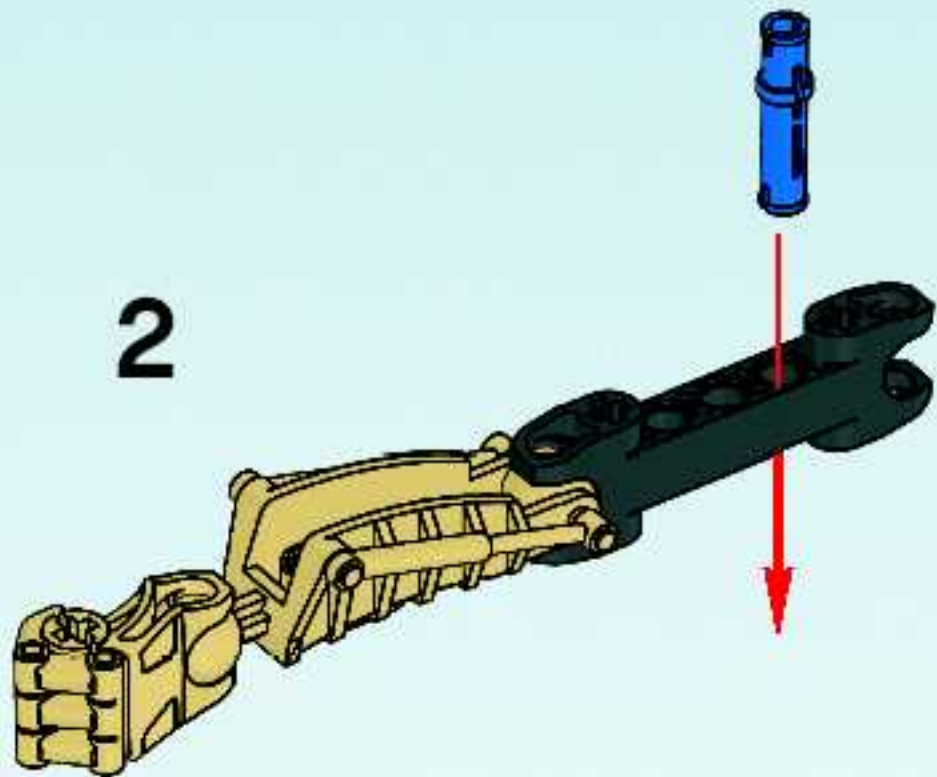

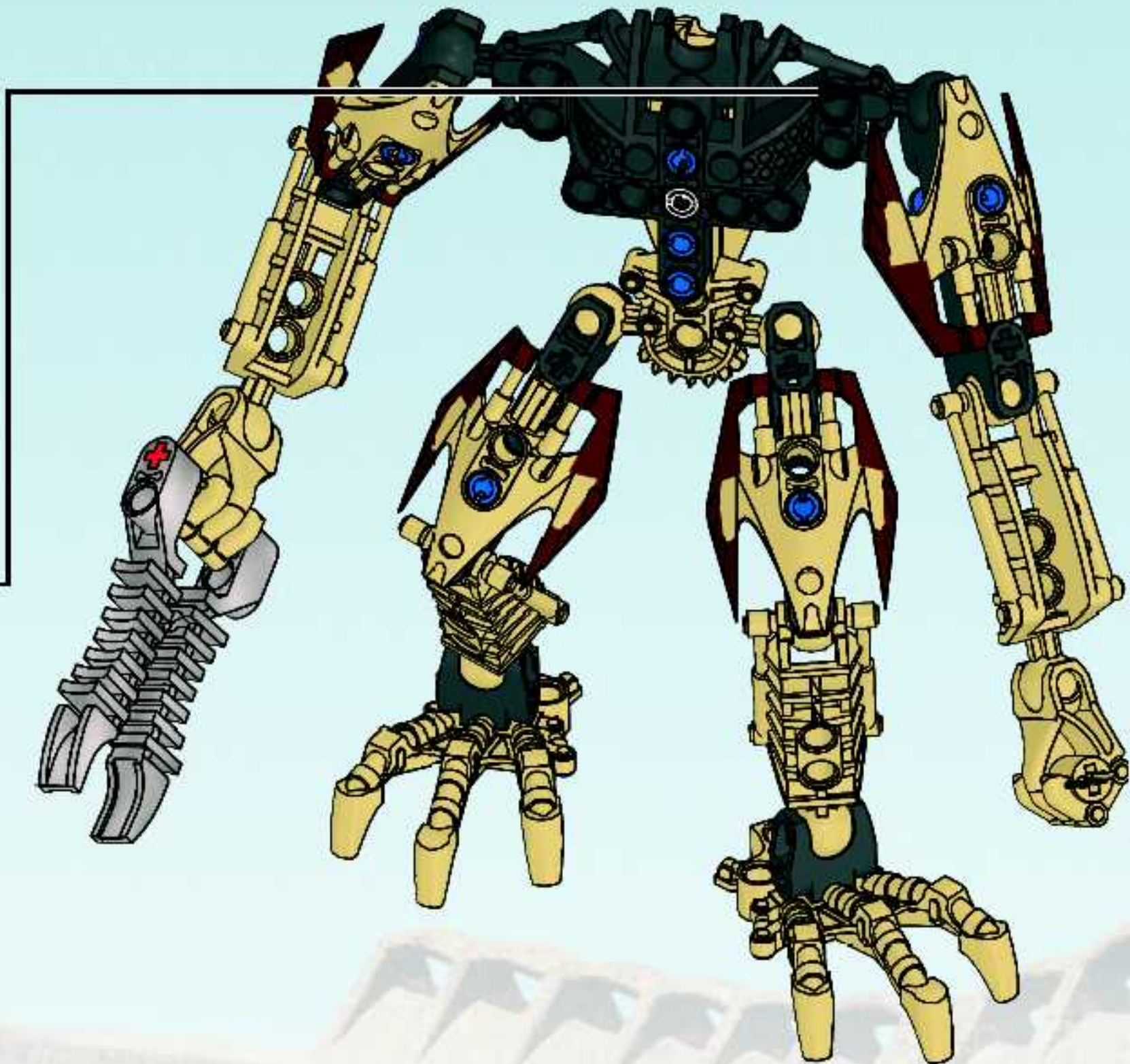

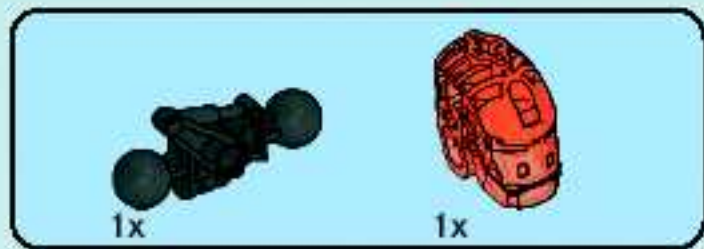

7

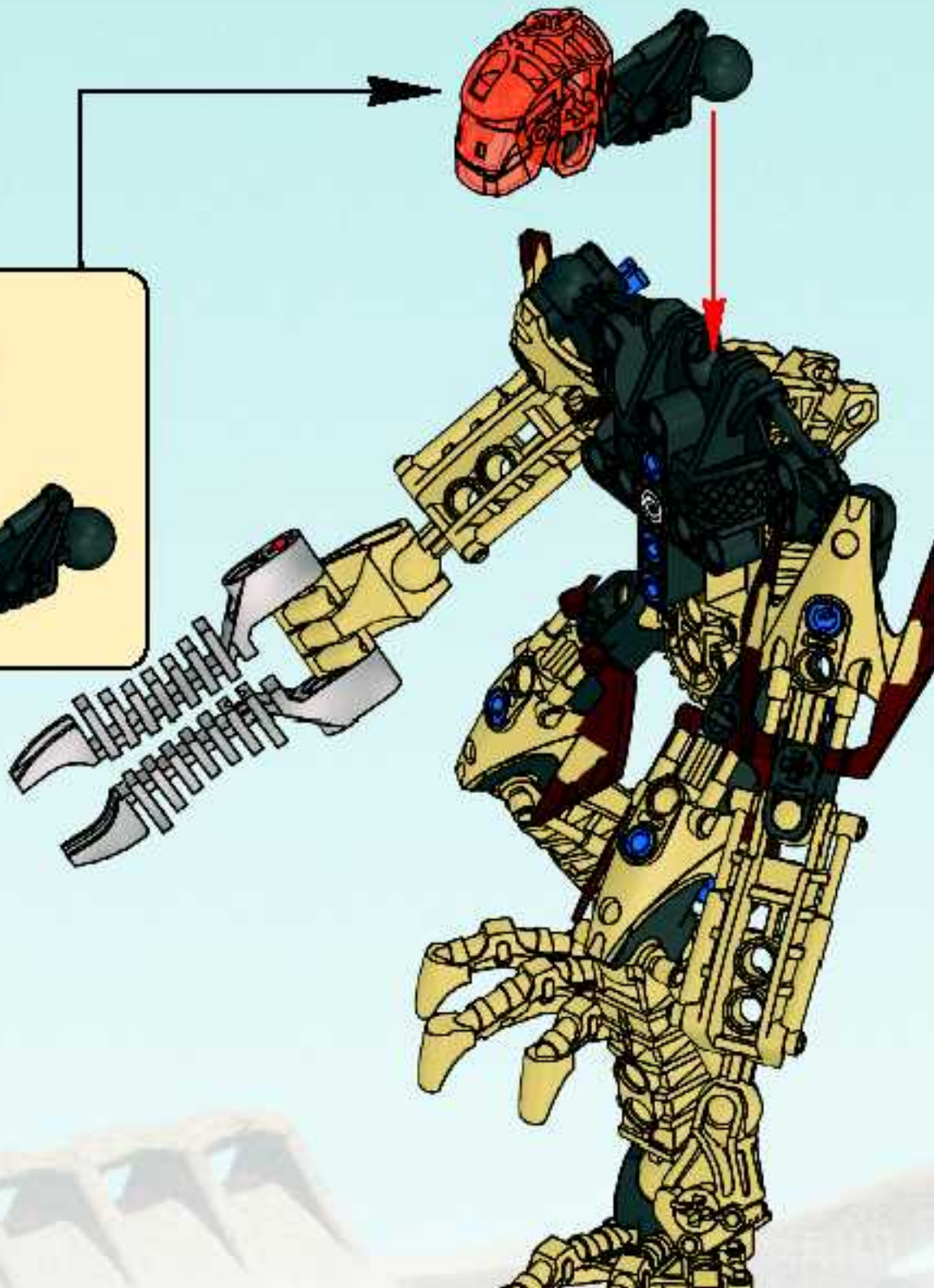
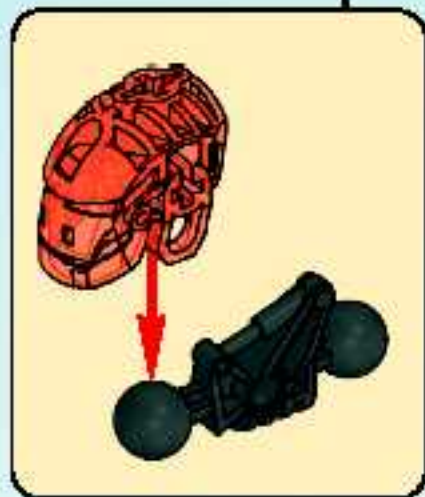



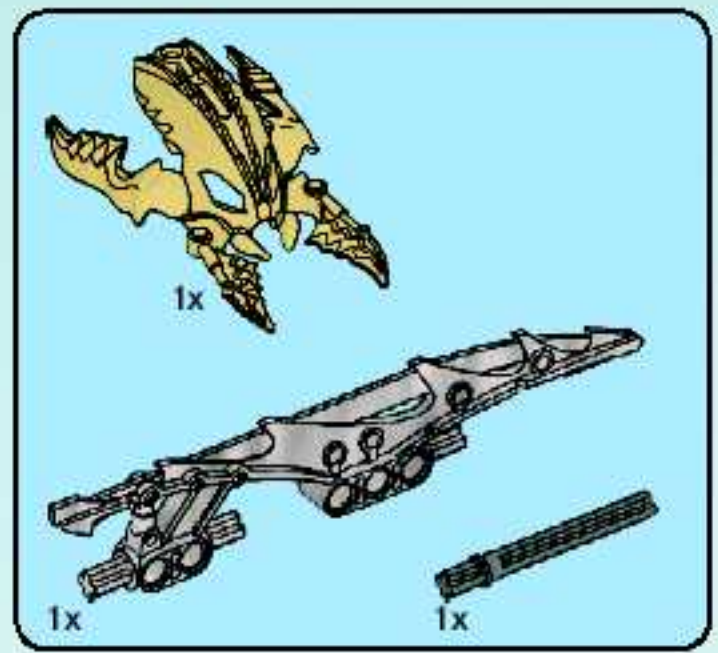

8

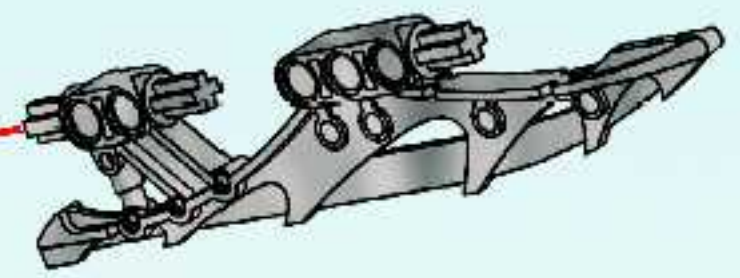

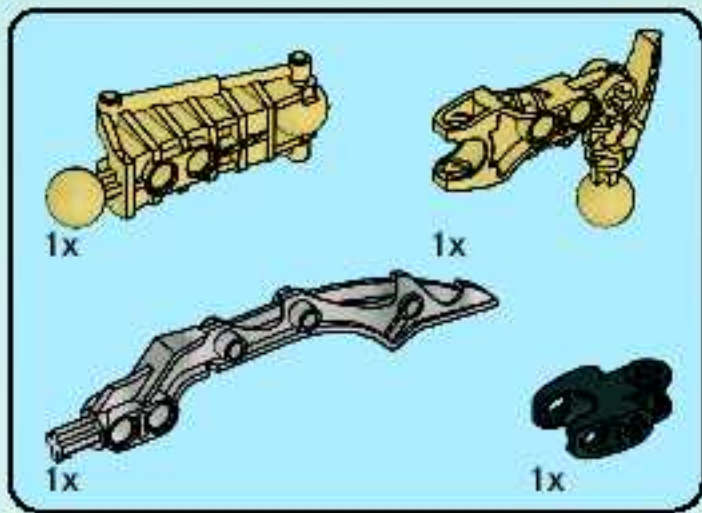

9

1

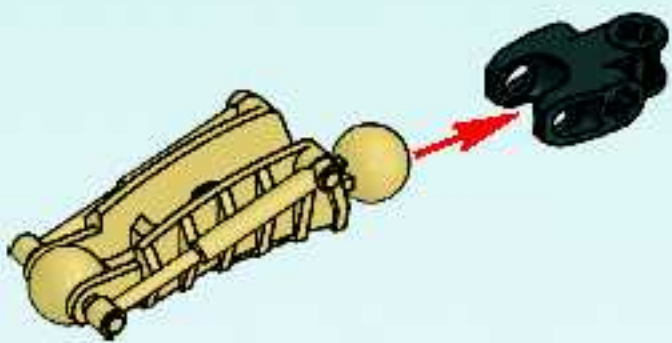

2

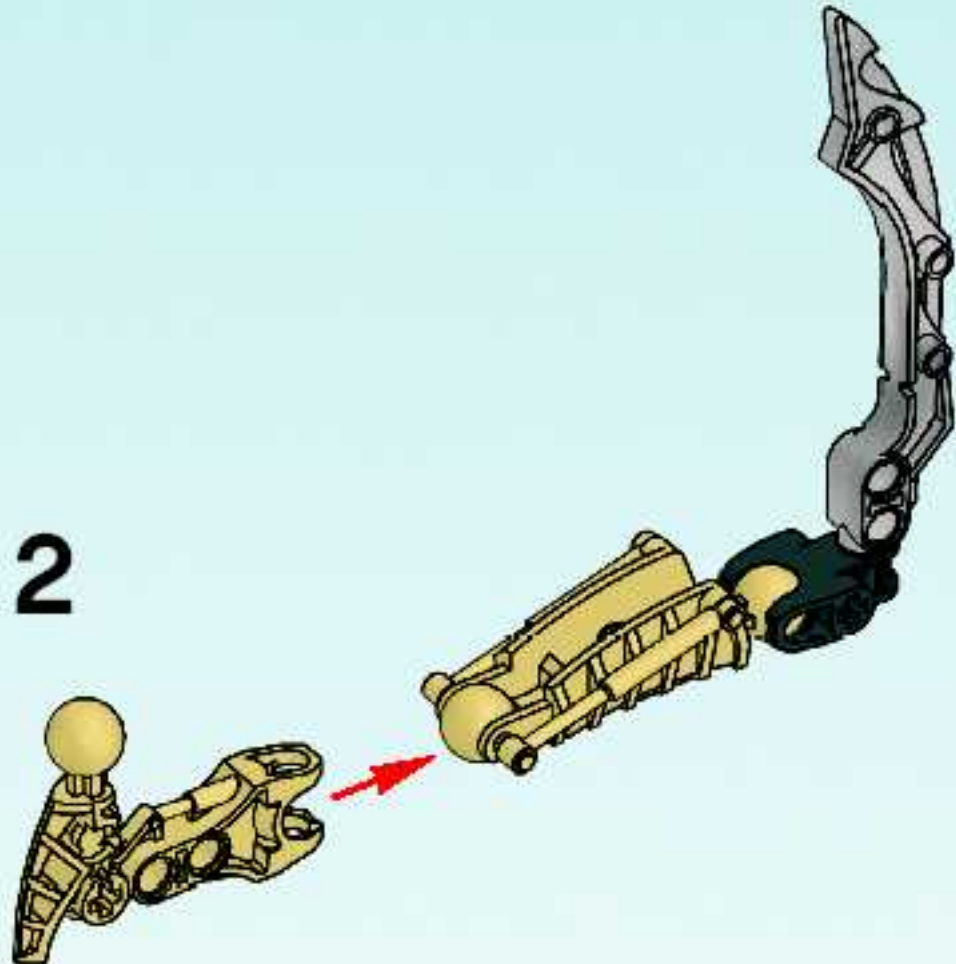

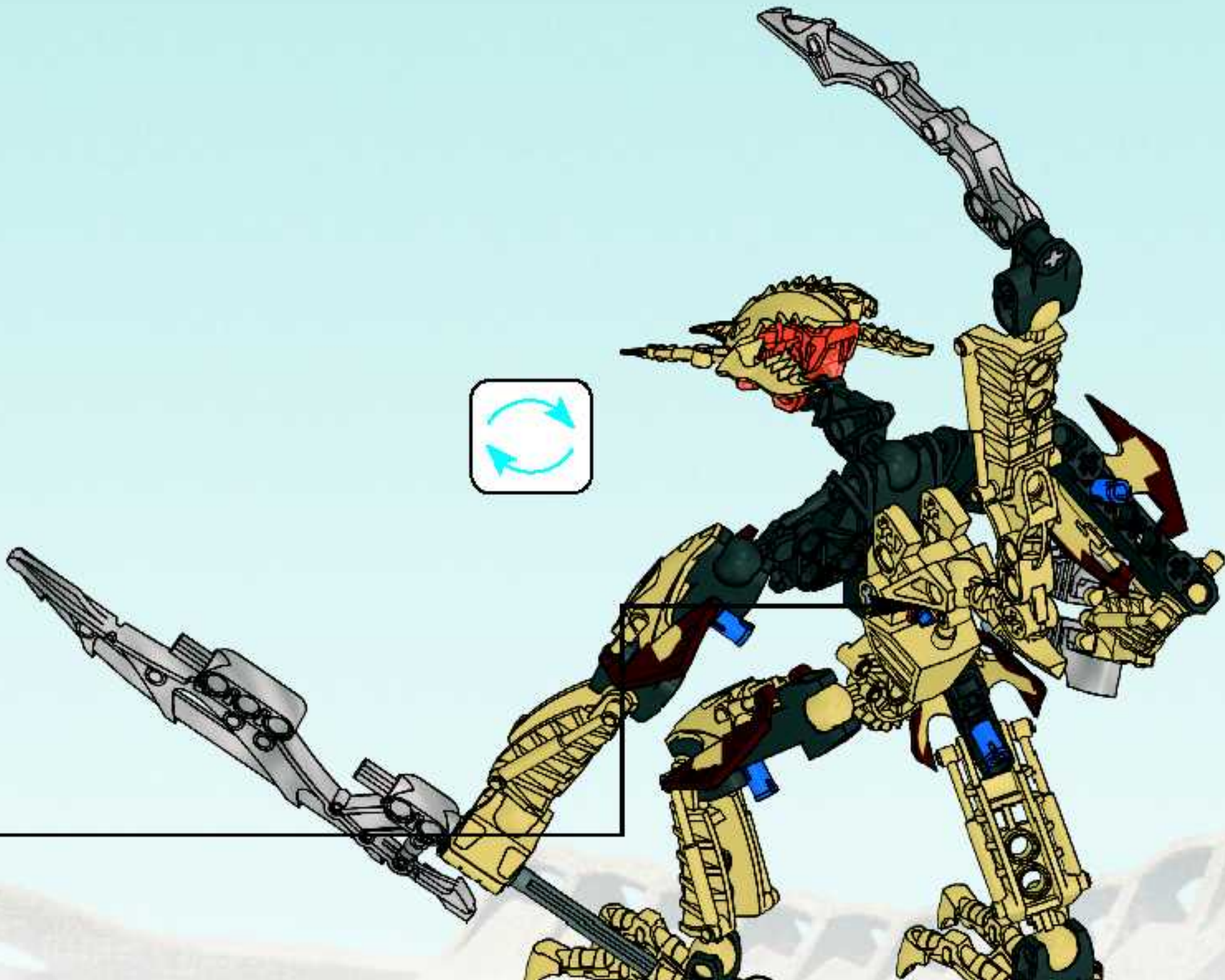

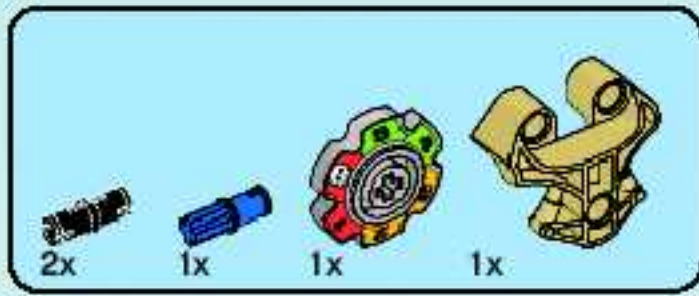

# 10

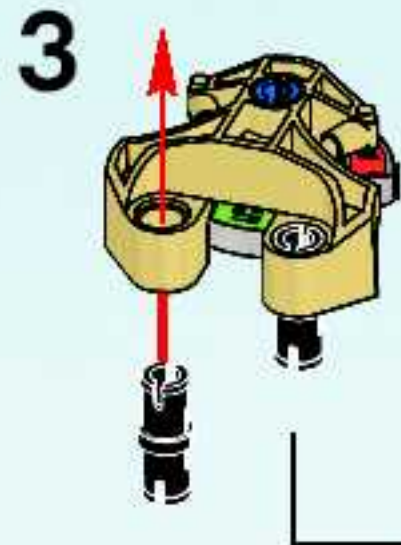
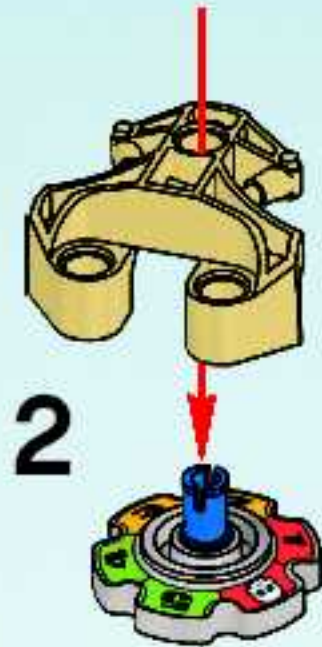
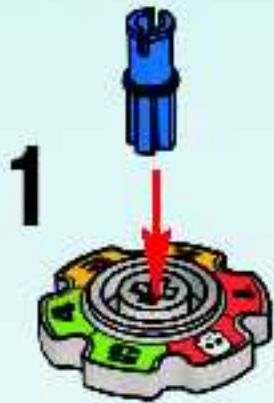

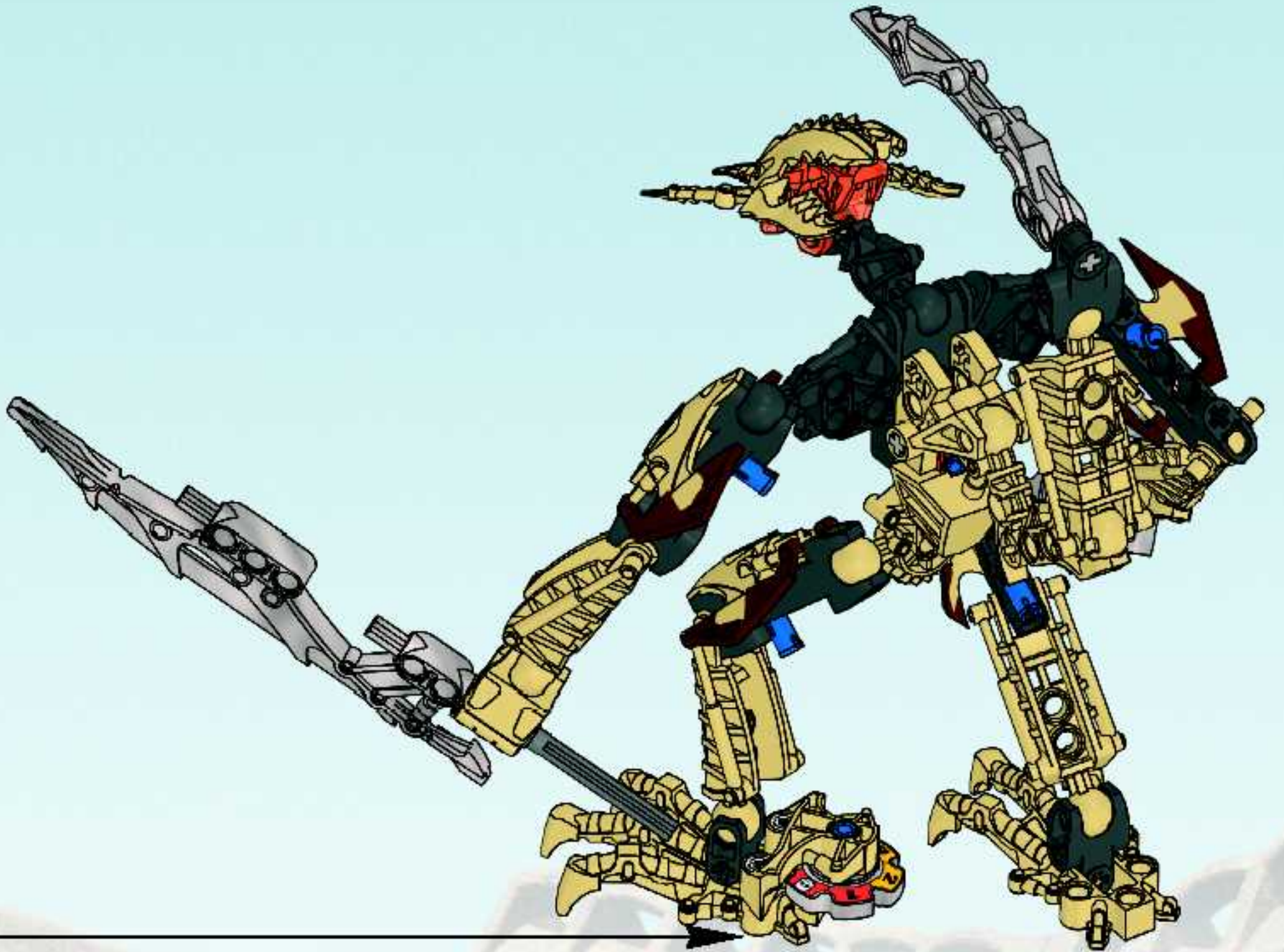

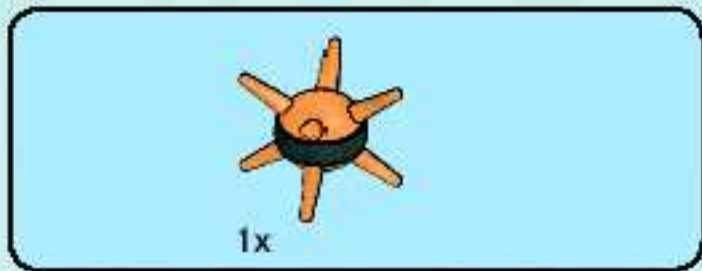

11

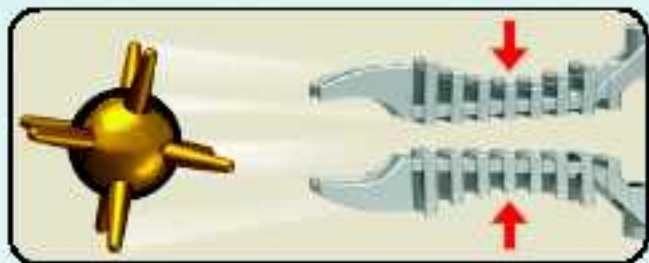
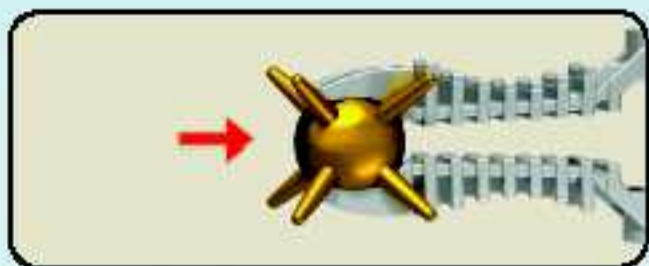



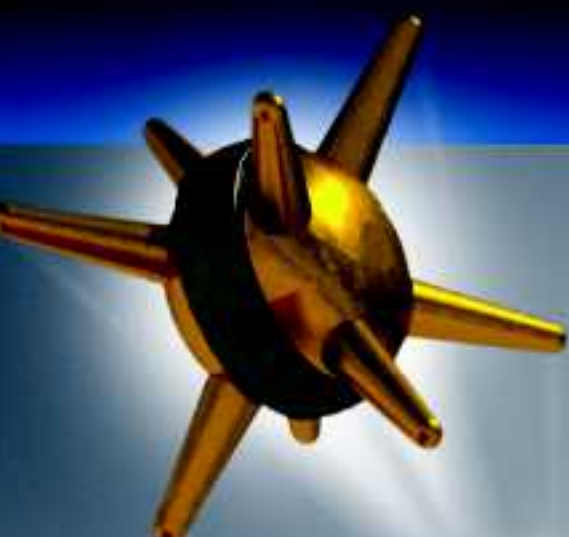

*BIONICLE ACTION FIGURE*  
**GAME**





## Setting Up Préparer le jeu

## Prepara el juego

This game is about taking the life of your opponent before he takes yours!

1. Set up the game using 2 cans & 2 figures
2. Set the dial to 5
3. Decide who goes first

Pour gagner, il faut que tu t'empares de la vie de ton adversaire avant qu'il ne s'empare de la tienne !

1. Installe le jeu en utilisant 2 boîtes et 2 figurines
2. Positionne le cadran sur 5
3. Décide qui commence

¡El objetivo de este juego es ganar la vida de tu oponente antes que él gane la tuya!

1. Prepara el juego utilizando 2 latas y 2 figuras
2. Coloca el marcador en 5
3. Decide quién empezará



## Playing the game: **POINTS**

## Jouer au jeu : **POINTS**

## Cómo jugar: **PUNTOS**

1. Hit can and opponent loses 1 life point or hit figure and opponent loses 2 points.

1. Si tu touches la boîte, ton adversaire perd 1 point de vie et si tu touches la figurine, ton adversaire perd 2 points.

1. Golpea la lata para que tu oponente pierda 1 punto de vida, o golpea la figura para que pierda 2 puntos de vida.



Playing the game: **MOVE**  
Jouer au jeu : **AVANCE**

Cómo jugar: **AVANZA**

1. After shooting move figure to where ball lands.

1. Après avoir tiré, déplace la figurine à l'endroit où la balle a atterri.

1. Después de disparar, mueve la figura hasta el lugar en el que haya caído la bola.



Gana el Juego

Winning the game  
Gagner la partie

1. The first player to take all the opponent's life points wins!

1. Le premier joueur qui s'empare de tous les points de vie de son adversaire gagne !

1. ¡El primer jugador que junte todos los puntos de vida de su oponente ganará!



Team up  
Fais équipe

Agranda tu equipo

8988



8981



8982



8976



8975

8990



8977

For more rules on advanced multi-figure game play

Pour plus d'information concernant les règles des jeux de niveau avancé avec plusieurs figurines, visitez

Para más información sobre instrucciones de juego avanzado con varias figuras, consulta

8980



[www.BIONICLE.com](http://www.BIONICLE.com)

8974



8978



8991



8979



8972

8973





8972



8973



8974

[www.BIONICLE.com](http://www.BIONICLE.com)



8975

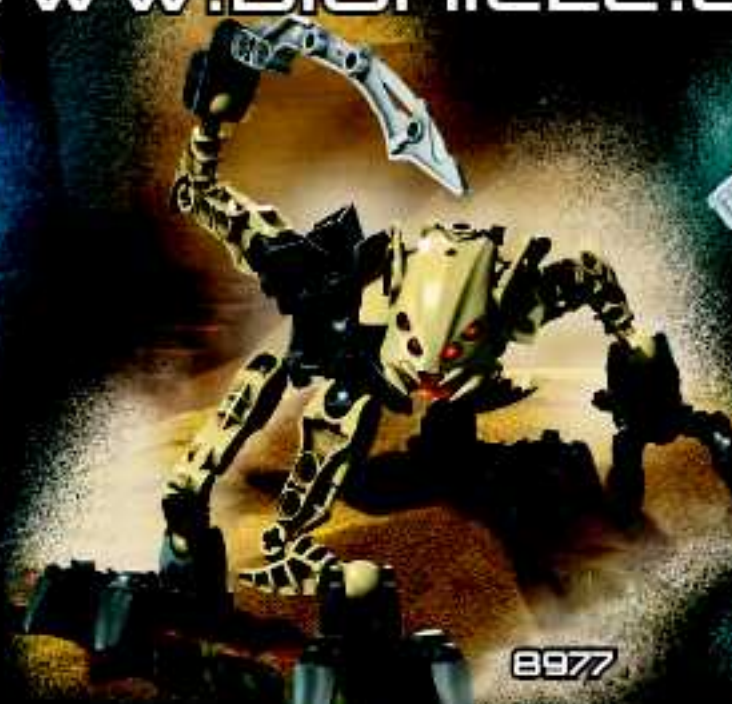

8977



8976

FERO &  
SKIRTMIX

TUMA



8990

8991

[www.BIONICLE.com](http://www.BIONICLE.com)

**FREE! GRATIS! GRATUIT!**



**club**  
MAGAZINE™

**www.LEGOclub.com**



**00800 5346 5555\***        

  **1-866-534-6258 • 1-877-518-5346**

US & Canada only

Canada seulement

\* FreePhone. Mobile charges may apply. \*\* Numéro sans Frais. Des Frais peuvent s'appliquer avec les téléphones cellulaires.

\* Gelokkeerd Frek. Kosten Rijk Aanreke aus Mobilfunknetzen können anfallen. \*\* Gratis bel Freenummer voor vaste lijn. \*\* Het erelt gratis nummer, nar du ringer Fra Postbetalet.

\* Delir gratis, nar du ringer Fra en Post betalet.



VISIT THE WORLD'S  
BIGGEST LEGO® SHOP!

**www.LEGOshop.com**



## WIN LEGO® PRODUCTS

Fill out a survey and you might WIN a cool LEGO product!  
NO PURCHASE NECESSARY  
Open to all residents where not prohibited  
Go to [www.acnielsen.ai.mdk/LEGO](http://www.acnielsen.ai.mdk/LEGO) to fill out a survey for a chance to win a LEGO product.

## WIN LEGO® PRODUCTEN

Vul een enquêteformulier in en maak kans op een cool LEGO® product!  
Kopen niet nodig  
In landen uit landen waar geen enquêteverbod geldt mag deelnemen.  
Ga naar [www.acnielsen.ai.mdk/LEGO](http://www.acnielsen.ai.mdk/LEGO), vul een enquêteformulier in en maak kans op een LEGO product.

## GEWINNE LEGO® PRODUKTE

Nimm an der Umfrage teil und GEWINNE ein tolles LEGO® Produkt!  
Die Teilnahme am Gewinnspiel führt zu keinerlei Kaufverpflichtungen  
Teilnahme in allen nicht ausgeschlossenen Ländern möglich  
Wir verlosen unter allen Teilnehmern der Umfrage auf [www.acnielsen.ai.mdk/LEGO](http://www.acnielsen.ai.mdk/LEGO) LEGO Produkte.

## GAGNE DES PRODUITS LEGO®

Réponds à un questionnaire et tu pourrais GAGNER un produit LEGO® très cool !  
Aucune obligation d'achat.  
Ouvert à tous les résidents des pays autorisés.  
Visite [www.acnielsen.ai.mdk/LEGO](http://www.acnielsen.ai.mdk/LEGO) pour répondre à un questionnaire et avoir une chance de gagner un produit LEGO.

## レゴ®製品を「当てよう」

アンケートに記入して、かっこいいレゴ®製品を当てよう！  
お買い上げの必要はありません。  
禁止されていない限り、すべての皆様にご利用いただけます。  
[www.acnielsen.ai.mdk/LEGO](http://www.acnielsen.ai.mdk/LEGO)にアクセスして、アンケートにご記入ください。当選者にはレゴ®製品を差し上げます。

